

BS-821/KIT BATTERY OPERATED WIRELESS PROGRAMMABLE CHRONO-THERMOSTAT WITH COOLING AND HEATING FUNCTION & BOILER OUTPUT

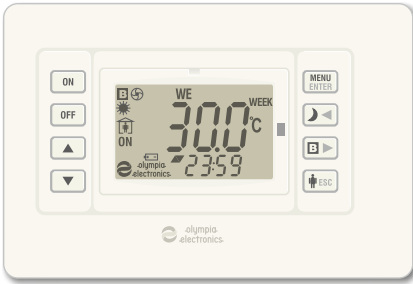

BS-818/T - BS-819/T

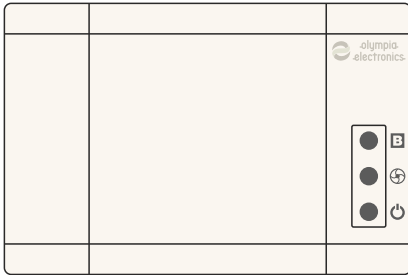

BS-821/R

- *Wireless connection between the thermostat and the Relay.*
- *RF signal strength indicator.*
- *3 operation modes: manual, daily, weekly.*
- *8 key easy operation.*
- *Easy program entry.*
- *Multi indication screen with back light.*
- *Clock, Calender.*
- *Keypad lock.*
- *Selection of upper and lower limits for manual temperature selection.*
- *Boiler operation (BS-819/T) with selectable time.*
- *Heating and Cooling function.*
- *Easy connection - adjustment.*

*Thank you for your trust in our products
Olympia Electronics - European manufacturer*

The key is like this on the BS-818/T.

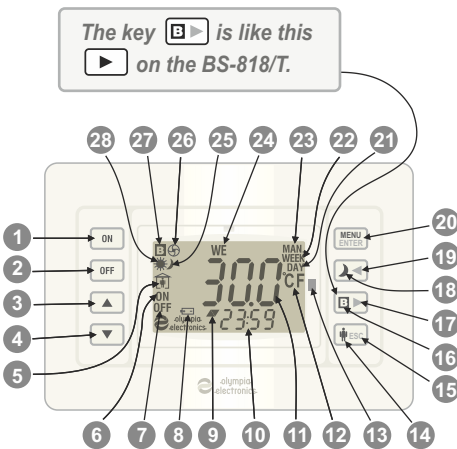

CONTROL AND INDICATOR DESCRIPTION

- 1 . Thermostat activation
 - 2 . Thermostat deactivation
 - 3 . Increase value
 - 4 . Decrease value
 - 5 . Presence indicator
 - 6 . Thermostat active
 - 7 . Thermostat inactive
 - 8 . Battery state indicator
 - 9 . Ascending or descending temperature indicator
- ▼ = When the selection is less than the actual temperature.
 ▲ = When the selection + the differential is more than the actual temperature.
 ▲▼ = When the temperature is between the selection and the selection + the differential.

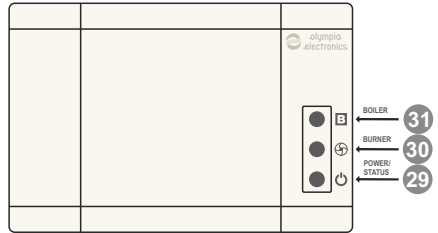
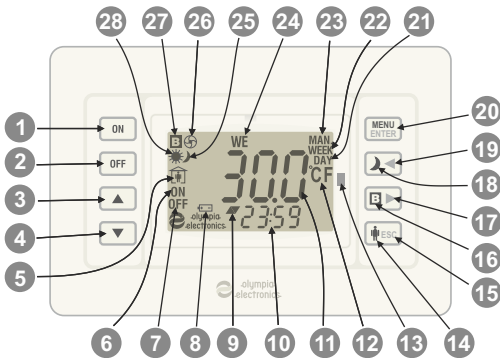



- 10 Hour and message display
- 11 Temperature and message display
- 12 Temperature units display
- 13 Active burner output display
- 14 Selecting on not the area presence program
- 15 Escape from a selection
- 16 Activate / Deactivate boiler (*valid only for the BS-819/T*)
- 17 Go to the next item or selection
- 18 Select normal or night program
- 19 Go to the previous item or selection
- 20 Select and confirm installation settings
- 21 Daily program activation indicator
- 22 Weekly program activation indicator
- 23 Manual program activation indicator
- 24 Day of the week indicator
- 25 Night program activation indicator
- 26 Burner activation indicator
- 27 Boiler activation indicator (*valid only for the BS-819/T*)
- 28 Normal program activation indicator

- 29 Power supply and programming status indicator
- 30 Burner activation indicator
- 31 Boiler activation indicator (*valid only for the BS-821/R*)

CONTENTS







<ul style="list-style-type: none"> Entering the MENU, page.3 Day or Night operation, page.3 Boiler activation selection, page.3 Presence selection, page.3 Keypad lock, page.3 Setting time-date, page. 4 Setting the daily program, page.4 Setting the weekly program, page.4 Setting the limits of the manual program, page.4 Thermostat operation mode, page.5 Temperature indication unit, page.5 Screen illumination, page.5 	<ul style="list-style-type: none"> Burner output indicator, page.5 Manual operation time, page.5 Differential value, page.5 Heat-Cool selection, page.5 Hour meter, page.6 Factory settings, page.6 Battery changing, page.6 Screen messages, page.6 Daily programming example, page.7 Weekly programming example, page.8 Wireless communication settings, page.8 communication errors, page.9
---	--

GENERAL

When the plastic battery separator is removed the unit is automatically activated and shows all the screen indicators for 1", then the firmware version is shown and finally the screen enters final operation status. In the center of the screen we can see the current temperature. The clock has the hour 00:00, the date is 1 January (Friday) 2016 and the thermostat is inactive (OFF state). In this state the only available selections are Boiler activation /deactivation (only for BS-821/KIT) and entry to the settings menu. If the  key is pressed momentarily, the screen illumination will be activated for 2" and the symbols ,  and **MAN** will be shown which are the factory defaults.





1. ENTERING THE MENU *(the thermostat in the OFF state).*



To enter the menu settings press the button  for more than 3".

The screen will be illuminated and will stay illuminated during all the duration of the settings. Please note that only settings that are blinking can be changed. To navigate through the menu items use the keys  and . To change the value of a menu item use the keys  . Press the  key to accept the change or press the  key to go to the previous state. If no key is pressed for 2 minutes then the thermostat returns to normal operation while saving the changed settings.



2. SELECTING DAY OR NIGHT OPERATION MODE

(the thermostat is in the ON state and in manual operation).

If the  key is pressed for more than 3" then the  indication is deactivated and we can see the . This means that night operation mode has been selected. This selection replaces temporarily the manually selected temperature for as long as the night program is active. If one of the keys   is pressed then the set night program temperature is shown. (this can be changed from the setting *ni t* (night) of the MENU). The factory default night temperature is set to 18.0°C. To deactivate







the night program, press the  key for more than 3", the symbol  is replaced by the symbol .

3. Boiler ACTIVATION *(available only on the BS-819/T).*





This capability can be executed by pressing briefly the  key, the backlight will be activated for 2" and the  symbol will be shown on the top left corner of the screen. The built-in relay will send the command to the burner. The command will be active for as long as it has been preselected via the MENU setting with the indication *bot.* (Boiler time), or until the  key is pressed again. If the preselected Boiler value is 00 then the deactivation can be done only with the key. The Boiler command is independent from the other functions of the device and can be given even if the thermostat is deactivated (OFF state). The factory default Boiler time is 00 minutes.

4. AREA PRESENCE SELECTION *(The thermostat is in the ON state).*

In normal operation, the symbol  shows the presence of people in the area and all the programs, which ever they are, are executed normally. In limited absence from the area (from a few hours to a few days) there is the capability to execute the absence program.









If the  key is pressed for 3", the backlight will be activated for 2" and the  symbol will be changed to . This command superimposes every other program. The selected temperature is shown on the screen if any of the   keys is pressed and can't be changed. The value can be changed only with the *Abst* selection (Absent time) of the MENU. The factory default setting of this temperature is 16.0 °C and can be altered from 6.0 to 30.0 °C. To deactivate the absence mode, the key  must be pressed for 3", then the thermostat will continue the execution of the program that was running before absence mode was selected.

5. KEYPAD LOCK *(in any operation state).*

If the keys  and  are pressed simultaneously for 3" (first the  key and then the ) , the screen will show the message *lock* and the keypad is locked.



Which ever key is pressed after this will show the same message on the screen. All other function are executed normally. To unlock the keypad follow the same procedure and the screen will show the message *ULoC* .







6. SETTING THE TIME AND DATE *(the thermostat is in the OFF state)*.

To enter time adjustment mode press the key  for 3" as mentioned in paragraph 1. The backlight will be activated and the lower section of the screen will flash the message *SEt* (Set Time). After that press briefly the  key and the hours indicators will start to blink. Use the keys   to set the correct time. Pressing the  key will cause the minutes indicators to blink and with the keys   change to the correct value. Pressing again the  key we can adjust consecutively the year, month and date. You can see that the day names are changed automatically depending on the year, month and date. In normal operation the clock has leap year and daylight savings time correction.

7. SETTING THE DAILY PROGRAM.

(the thermostat is in the OFF state).





If immediately after entering the MENU parameters we press the  key then the blinking message *dAY* (Day) will be shown on the bottom of the screen and the word **DAY** on the top right. By pressing the key  the message *P1* (Program 1) is shown in place of the *dAY* message.

In the center of the screen and if programming is done for the first time we can see the message - - - -. By pressing the key  the hours indicators blink and we can alter the setting by using the keys   .By pressing the  key we can alter the minutes and the required temperature. With the  key we can return to the initial position with the blinking *P1*. With consecutive presses of the key  we can select the remaining programs of the 24 hour cycle (10 in total) and can set the required time periods and temperatures as described above. Please note the for every program we define only the start time since the end time is the start time of the next program. For example, if we

require a temperature of 23.0 °C from 14:00 to 18:00 in program 1 we will set the start time 14:00 at 23.0 °C and the start time of the second program 18:00 with the required temperature. The 24 hour time base starts at 00:00 and ends at 23:59'.

The start time of the next program must also be bigger than the start time of the previous. If no more changes are required and when the program indicator is blinking (e.i *P3*) we can press the key  to store all the changes and the screen will show the message *SAvE* . The programs that have not been adjusted are not taken into account.

8. ADJUSTING SETTINGS FOR THE WEEKLY PROGRAM. *(the thermostat in the OFF state)*.

If immediately after entering the MENU we press the  key for 2 times the message *7days* will be shown on the bottom of the screen and the word **WEEK** on the top right. On the top left of the screen there is the message **MO** (Monday) that shows the day that corresponds to the programming that follows. By pressing again the key  the screen shows a blinking *P1* that determines the first program of Monday of the weekly program. The remaining procedure is as described in paragraph 7 (setting the daily program). Finishing the programming of the first day if we press the  key while the program number is blinking (e.i *P3*) will show the blinking message *7dAY* . With the  key we can select the day for which we want the alter the program as described above. If no other changes are required then press the key  to save the setting to memory. The screen will show the message *SAvE* . It is stressed that at least one program must be adjusted for every day else the factory default temperature of 23.0 °C will be used for all the 24 hour base.

9. SELECTING THE UPPER AND LOWER LIMITS OF THE MANUAL TEMPERATURE ADJUSTMENT *(the thermostat is in the OFF state)*.

After entering the MENU and by consecutive presses of the key  the message *HtL* (High Temperature Limit) will

be shown on the bottom of the screen as well as the initial value 30.0 °C. By pressing the key **MENU** we can change this temperature between the lower **LL** limit and the value of 30.0 °C. By pressing the key **ESC** and then immediately the **▶** key the lower section of the screen shows the message **LLL** (Low Temperature Limit) as well as the initial temperature of 6.0 °C. With the **MENU** key we can adjust the value between 6.0 °C and the value of the upper limit. The two limits define a temperature area that can be used by the user to enter the desired temperature. The selection of the limits influences the manual adjustment of the temperature and is independent from the operating mode of the unit (manual, daily weekly) and does not have any influence on the programs for daily or weekly operation.

10. OTHER MENU SETTINGS (*the thermostat is in the OFF state*).

All the menu settings that follow can be changed by using the same method as described in the previous chapters. After entering the MENU use the **▶** key to select the required setting. The messages are shown in the bottom section of the screen like this:

A. Mode (Mode) OPERATION MODE.

One of three operation modes can be selected:

USER (User) Manual mode (the symbol **MAN** is shown on the top right of the screen).

DAY (Day) daily operation (the symbol **DAY** is shown on the top right of the screen).

7DAY (7 Days) weekly program (the symbol **WEEK** is shown on the top right of the screen).

The factory default is **USER**.

B. Unit (Unit) TEMPERATURE UNIT.

The option are: **DEGC** or **DEGF** (Degree Celsius ṡ Degree Fahrenheit) and regard the display of the temperature in °C or °F. Depending on the selection, the symbol °C or °F are shown on the center right of the screen.

C. BL (Back Light) SCREEN ILLUMINATION.

With this setting we can turn off the screen

illumination in order to conserve battery energy. If **ON** (ON) is selected then the screen illumination will be activated every time a key is pressed. If **OFF** is selected then the screen illumination will be deactivated

The factory default is **ON**.

D. LED (LED) BURNER OUTPUT INDICATOR.

This setting can deactivate the burner output indicator in order to conserve battery energy. If **ON** (ON) is selected then when the burner output is active the indicator will briefly blink every second so the user has a knowledge of the state of the thermostat from a distance. If **OFF** (OFF) is selected then the indicator is deactivated.

E. TOU (Time Out) TEMPORARY TIME FOR MANUAL OPERATION.

With this setting we can determine the time period for which the manual temperature adjustment is valid. When the thermostat is running a daily or weekly program and we press the keys **▲** or **▼** then the thermostat enters briefly the manual mode for a time period that is determined by the setting **TOU**. The value of this setting can be from 3 to 10 hours after which normal program execution is continued. The factory default is 3 hours.

F. DIFF (Differential) DIFFERENTIAL SETTING.

This setting determines the "temperature window" between activation and deactivation of the burner output. For example, if the thermostat is set to heating and the room temperature is set to 23.0 °C then with a differential of 0.5 °C the output to the burner will be deactivated at 23.0 °C and will be reactivated at 22.5 °C. If the device is set to cooling mode then the output will be deactivated at 23.0 °C and will be reactivated at 23.5 °C. The differential value can be set between 0.2 °C and 4.0 °C.

The factory default value is 0.2 °C.

G. HELO (Heat/Cold). SELECTING HEATING-COOLING MODE.

This setting determines the operation mode of the thermostat which can be heating or cooling. By selecting **HEAT** the device can

control heating units (e.i. diesel burners), whereas with the selection Cool it can control cooling units (e.i. air-conditioners).

H. TIME (Time) HOUR METER.

In this screen position we can see the total operation hours of the burner or the cooling unit. This value can not be altered by the keypad but can be reset if the battery is removed. the maximum value is 9.999 hours.

I. FACT (Factory settings)

SELECTING THE FACTORY DEFAULT SETTINGS.

If for any reason there is the need to restore the thermostat to its factory default settings then this setting will restore then is we select YES and press the key MENU . This does not affect the time and date settings.

The factory default setting is NO .

11. CHANGING THE BATTERY

When the screen shows the BATT symbol the unit warns use that the batteries have limited energy and that they must be replaced in the next 3 weeks. To replace the batteries simple remove the cover (Fig. 2) to expose the battery compartment. Remove the batteries and within 30 seconds reinsert new ones in order to avoid a reset of the device. Should this happen it will require to adjust the time and date again. All other setting remain unaffected. Avoid replacing the batteries with the backlight activated, /this will immediately reset the device and the hour meter. Take care of the battery orientation and insert the new batteries according to the graphic representation etched on the plastic base. The reverse installation will not harm the device but it will not permit it to operate.

The battery life time has been design to be approximately 2 years. Factors that influence the battery life are prolong use of the keyboard with the backlight active, increased temperature and humidity as well as battery quality.

12. ANTI-ICE PROTECTION

If the room temperature in which the thermostat is installed falls below 5°C , the unit activates the burner output irrelevant of the ON or OFF state of the thermostat to prevent ice build up. The burner output is active for as long as the temperature is below 5°C .

13. CLEANING THE THERMOSTAT

To clean the device use a damp cloth to remove any dust or stains from the covers. Do not use any liquid or dissolvers that will damage the plastic covers.

14. SCREEN MESSAGES

Following you can see a complete list of screen messages that can be seen by consecutively pressing the RIGHT key:

SET = Set Time = Time and date setting.

DAY = Day = Daily program selection.

WEEK = Week = Weekly program selection.

MODE = Mode = Operation mode selection.

UNIT = Unit = Temperature unit.

BL = Backlight = Screen illumination.

LED = LED = Burner output indication LED.

TIME = Time out = Manual temperature time.

HTL = High Temperature Limit = Upper limit for manual temperature adjustment.

LTL = Low Temperature Limit = Lower limit for manual temperature adjustment.

BOIL = Boiler Time = Active boiler time

DIFF = Differential = Differential for burner relay.

ABST = Absent = Absence program.

NIGHT = Night = Night program.

HECO = Heat/Cold = Heat/Cold operation mode.

RF = RF = Wireless connection setting

FACT = Factory = Factory default settings.

MISCELLANEOUS INDICATIONS

LOCK = Lock = keyboard lock.

UNLOCK = Unlock = unlock keyboard.

SAVE = Save = Save settings to memory.

USER = User = Manual program

DEGC = Degree Celsius = Celsius temp. unit.

DEGF = Degree Fahrenheit = Fahrenheit temp. unit.

P1 = Program 1 to 10 = Program number from 1 to 10.

FACTORY DEFAULT VALUES

The following values are the factory default setting of the thermostat:

Thermostat state= **Inactive (OFF)**
Daily and weekly programs = **Not set**
Selected temperature value= **23.0°C**
Normal or Night program= **Normal**
Temperature unit= **Degrees Celsius**
Screen backlight= **Active (On)**
Burner activation indicator= **Active (On)**
Presence/Absence program = **Presence**
Manual selection time= **3 hours**
Upper manual temperature limit = **30.0°C**
Lower manual temperature limit= **6.0°C**
Boiler operation time= **30 minutes (BS-819/T)**

Boiler state= **Inactive (BS-819/T)**

Operation mode = **Manual (User)**

Differential= **0.2°C**

Absence temperature= **16.0°C**

Night program temperature = **18.0°C**

Heating/cooling function= **Heating**



Keypad state= **Unlocked**

DAILY PROGRAMMING EXAMPLE

Lets assume that we want to program the following temperatures and hours (programs): From 07.00 to 08.30 at 22,5°C. From 8.30 to 12.00 at 21,5°C. From 12.00 to 17.30 at 18,5°C. From 17.30 to 23.00 at 22,5°C and from 23.00 to 07.00 at 19,8°C.



Note that the end hour of each program is the start hour of the next program and always the start hour of a program is at least 1 minute greater than the end hour of the previous program. It is essential to select at least 1 program per day otherwise the thermostat will operate with the factory defined temperature of 23°C. Also note that the first program is considered the program with the start hour nearest to the hour 00.00 (e.i. 07.00).

1. Turn OFF the thermostat by pressing the corresponding key.



2. Press continuously the key  for 3 seconds . The screen back light is activated and the screen shows . Now we are in programming mode of the thermostat parameters.



3. Press the key  9 times and the screen shows  with the *Mode* (Mode) blinking.



4. Press the key  and the *USEr* starts to



blink. With the keys  and  we select the operation mode *day* (Day - daily program).



5. Press the key  and we return to the previous screen with the *Mode* blinking.

6. Press the key  8 times and the screen shows  with the *day* blinking. Now we are in the daily programming sub menu that has a 10 program capability.

7. Press the key  and the screen shows  with the *P1* blinking, this shows that we are in program 1 of the daily program. (the indication *----* indicates that the current program in empty).

8. Press the key  and the hours digit starts to blink. With the keys   select 07.

9. Press the key  and the minutes digit starts to blink. With the keys   select 00.

10. With the next press of the  key the screen shows the temperature blinking and by using the   keys we select 22,5°C. This concludes the programming of the first program.



11. Press the  key and the screen shows the symbol *P1* blinking.

12. Press the  key and the *P2* symbol will blink. This shows that we are in the second program.

13. Follow the step 8, 9 and 10 and set the time to 8.30 (which is the end time of the first program) and the temperature to 21,5°C.











14. Following the steps 8, 9, 10 and 11 to adjust the remaining programs with the values 12.00/18,5°C, 17.30/22,5°C and 23.00/ 19.8°C. If by mistake we add a new program (ex. P6), this program can't be canceled but can be defined as a new program with a start time of 23.01 and the same temperature as P5.

15. Completing the daily program we can store the programmed values to the devices memory by pressing 2 times the

 key while the indication *P5* is blinking. The screen will show  for awhile and then normal operation will continue. By activating the device with the  key the daily program will start to take affect. In order for the program to execute correctly make sure you have programmed the device clock with the correct time.



WEEKLY PROGRAMMING EXAMPLE.

The weekly program in general is based on the daily programming which is repeated for every day of the week independently. For the days of the week that have not been programmed, the values of the last programmed day are valid. If for example, we program only the days Monday to Wednesday, then the programming for Wednesday will be used for the days Thursday to Sunday. If we program only the days Monday, Wednesday and Thursday then for Tuesday's program the program from Monday will be used and for the days Friday, Saturday, Sunday the program from Thursday will be used.

1. Follow the steps 1, 2, 3, and 4 of the daily programming. Select in the *ModE* (Mode) section the setting *WEEK* and press the key .
2. Press 7 times the  key and the screen shows  with the *WEEK* indication blinking. The symbol **MO** (Monday) means that we are ready to program the Monday program and the symbol **WEEK** that we are in weekly programming mode.
3. Press the  key and the screen shows . From now the procedure follows the steps 8-14 of the daily programming and we can set the required temperatures on the required time.
4. Completing the programming of the Monday program press the  key and the screen shows  with the *WEEK* indication blinking. By pressing the  key, the day indicator changes to **TU** (Tuesday) and we can repeat the steps for programming a new program for Tuesday. The same can be done for the rest of the days of the week.
5. The completion of the weekly programming can be done by pressing the key  when the indicator *WEEK* is blinking. The screen will show the message  briefly and the settings will be stored in to the devices memory.
6. Activate the device using the  key. The weekly program will start to execute as defined. In order for the program to execute correctly make sure you have programmed the device clock with the correct time.

WIRELESS CONNECTION SETTING

This procedure is required for every new installation in order to establish the communication and to verify the quality of the signal.

After installing the peripheral received (BS-821/R), the key marked BT1 must be pressed (fig.5, page 11) until the indicator POWER/STATUS(LD1) starts to blink in a rapid manner. This shows that the unit is in programming mode. After activating the thermostat by removing the battery separation tape, go to the selection *OFF* (the thermostat in the OFF state, prolonged press of the MENU/ENTER key and then 22 consecutive presses of the key  lead us to the screen ). The number of dashes verifies the correct connection between the two devices and also shows the strength of the signal. The thermostat must be placed in such a position that will allow good signal strength which means that at least 2 dashes must be shown. If less than 2 dashes are shown the communication between the two devices is not good and can lead to communication errors and bad operation.

To completion of the wireless installation procedure is done by pressing the  key on the thermostat and by a prolonged press of the BT1 button on the peripheral until the POWER/STATUS(LD1) indicator stops to blink and remains ON.

We must select mounting areas away from heating elements, door and window openings and fireplaces and in general, away for all heat sources and away from drafts. Mount the thermostat at a height of about 1.5 meters and on an interior wall (The external wall have a lower temperature then that of the internal wall and can affect the device).

COMMUNICATION ERROR

Errors can occur if for any reason the communication between the two devices is disrupted. The screen of the thermostat will show the message CoEr (Communication Error), the backlight of the screen will blink.

The interruption of the mains voltage causes the interruption of communication between the two devices. When the voltage is restored, the peripheral device-receiver activates the outputs according to the state before the interruption, until the communication is automatically restored with the thermostat (maximum delay of 6 minutes), so the outputs will change according to the new commands that will be given.

Dimensions in mm

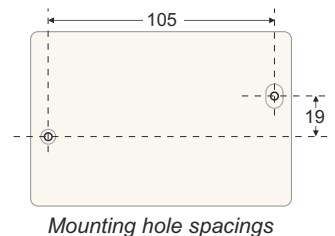
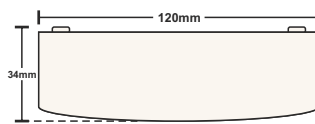
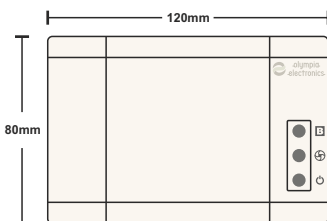
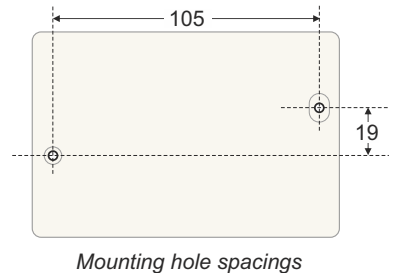
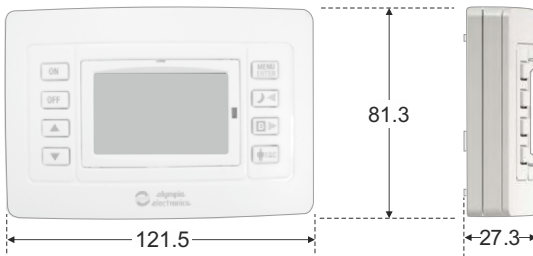

Installation procedure

To install the devices BS-818/T or BS-819/T, insert a flat blade screwdriver in the slot as shown in (Fig.1).

Press and lift the front cover. Remove the retaining screws and remove the plastic cover that contains the keys (Fig.2).

Use the supplied mount accessories to mount the unit according to the diagram of page 10. Install the base, align it using the built in vial and tighten the screw to secure it.

Reinstall the plastic containing the keypad with care and fasten the screws with a maximum torque of 0,5 Nm.

To activate the device, remove the battery separation tape (Fig.3).

Install the front cover with slight pressure and the device is ready to operate.



Fig. 1



Fig. 2

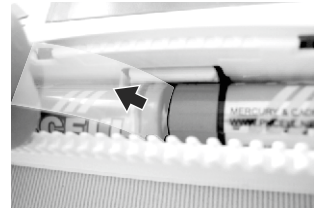

Fig. 3

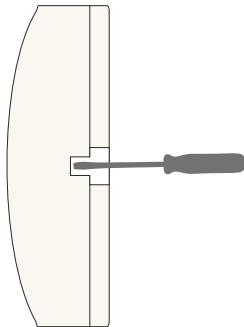

Fig. 4

To install the BS-821/R, remove the front cover with a screwdriver (Fig.4).

Mark and drill the mounting holes according to the schematic in page 10. Mount the device using the supplied mounting accessories (Holes A and B) as shown in Fig.5.

Do the electrical connections according to Fig.5.

Connect the phase to the L terminal and the neutral to the N terminal, this is used to power the device. The phase cable for the outputs is to the common of the relay contacts. In every activation, the contacts will provide the phase to the burner. Avoid installing the phase internally (from the L terminal to the relay common terminals) because it might cause interferences. The outputs are not fuse protected so any short circuit will destroy them and the device.

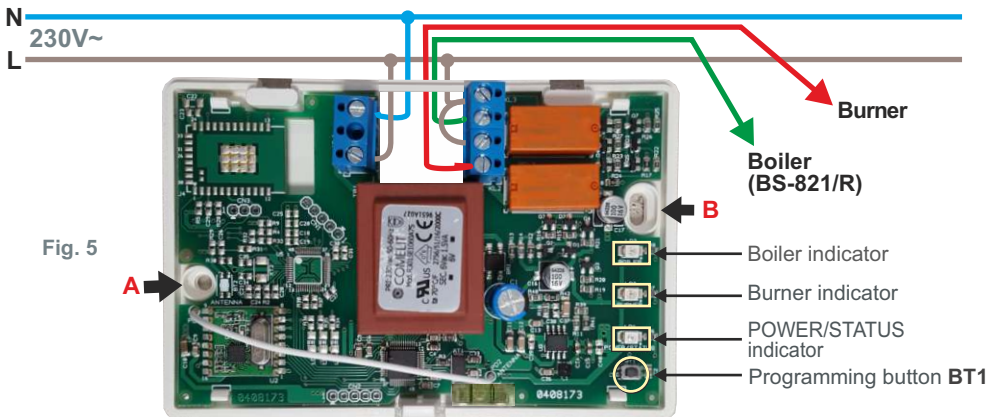

Fig. 5

TECHNICAL CHARACTERISTICS

MODEL	BS-818/T - BS-819/T	BS-821/R
BATTERIES	2 Alkaline AA	220 - 240V AC / 50-60Hz
CONSUMPTION	-	1.9VA
MEASURING RANGE	0.0 to 99.9 °C	-
TEMPERATURE SELECTION RANGE	6.0 to 30.0 °C	-
COMMUNICATION FREQUENCY	869,75MHz	
OPEN RELAY CONTACT	-	2x5A - 250V AC1
DEGREES OF COVER PROTECTION	IP20	
PRODUCED IN ACCORDANCE WITH	EN 61000-6-1, EN 61000-6-3, EN 60730-1, EN 60730-2-9	
OPERATION TEMPERATURE RANGE	5 to 35 °C	-10 to 50 °C
RELATIVE HUMIDITY	10 - 90% RH	10 - 95% RH
EXTERNAL DIMENSIONS	121.5 x 27.3 x 81.3 mm	120 x 34 x 80 mm
TYPICAL WEIGHT	175 gr. (with batteries)	200 gr.
GUARANTEE	2 years	

WARRANTY

Olympia Electronics guarantees the quality, condition and operation of the goods. The period of warranty is specified in the official catalogue of Olympia Electronics and also in the technical leaflet, which accompanies each product. This warranty ceases to exist if the buyer does not follow the technical instructions included in official documents given by Olympia Electronics or if the buyer modifies the goods provided or has any repairs or re-setting done by a third party, unless Olympia Electronics has fully agreed to them in writing. Products that have been damaged can be returned to the premises of our company for repair or replacement, as long as the warranty period is valid.

Olympia Electronics reserves the right to repair or to replace the returned goods and to or not charge the buyer depending on the reason of deflection. Olympia Electronics reserves the right to charge or not the buyer the transportation cost.

HEAD OFFICE

72nd km. O.N.R. Thessaloniki-Katerini
P.C. 60300 P.O. Box 06 Eginio Pierias Greece

www.olympia-electronics.gr
info@olympia-electronics.gr