

## BS-812/BS-813/BS-814

## BATTERY OPERATED PROGRAMMABLE CHRONO - THERMOSTATS

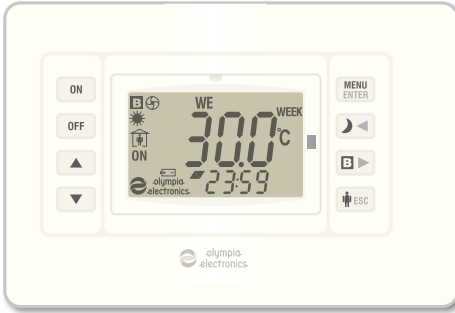

- *Extended battery life (>3 years).*
- *3 operation modes: manual, daily, weekly.*
- *Easy operation via 8 keys.*
- *Easy programming.*
- *Multi function LCD with backlight.*
- *Clock, calendar.*
- *Keyboard lock.*
- *Upper and lower limit settings.*
- *Manual temperature selection.*
- *Boiler option (BS-813) with adjustable time.*
- *Heating and cooling function.*

**Thank you for your trust in our products**  
**Olympia Electronics - European manufacturers**

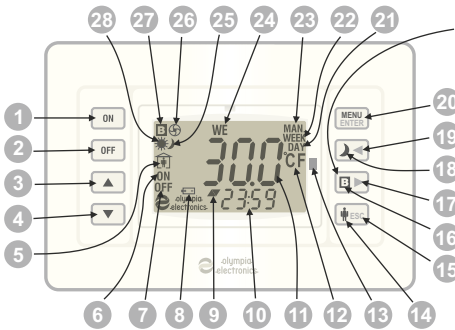



The key  is like this  on the BS-812,BS-814.

- 10 . Hour and message display
- 11 . Temperature and message display
- 12 . Temperature unit display
- 13 . Burner active indicator
- 14 . Presence program selection indicator
- 15 . Cancel/exit from selection
- 16 . Boiler activation / deactivation (valid only for BS-813)
- 17 . Go to the next selection or value
- 18 . Select normal or night program
- 19 . Go to the previous value or selection
- 20 . Select and confirm installation settings
- 21 . Daily program indicator
- 22 . Weekly program indicator
- 23 . Manual program indicator
- 24 . Day indicator
- 25 . Night program indicator
- 26 . Burner activation indicator
- 27 . Boiler activation indicator
- 28 . Normal program indicator

### DESCRIPTION OF CONTROLS - INDICATORS







- 1 . Thermostat activation key
  - 2 . Thermostat deactivation key
  - 3 . Increase value
  - 4 . Decrease value
  - 5 . Presence indicator
  - 6 . Thermostat active indicator
  - 7 . Thermostat inactive indicator
  - 8 . Battery status indicator
  - 9 . Temperature rise or fall indicator
- ▼ = when the selection is smaller that the actual temper
- ▲ = When the selection + the differential is greater than the actual temperature.
- ▲▼ = When the temperature is in the range between the selection and the selection + the deferential.

## GENERAL

When the plastic battery separator found between the two batteries is removed then the device is activated and all the symbols are shown on the LCD for 1", immediately follows a number that corresponds to the firmware version and then the initial screen. In the middle of the screen we can see the current temperature. The clock shows 00:00, the date is 1st January (Friday) 2016 and the thermostat is inactive (OFF state). In this state the only available options are the activation or deactivation of the boiler (only on BS-813) and the entry to the settings menu. If the button  is pressed momentarily the backlight will light for 2" and the symbols ,  and **MAN** which are the factory default.





### 1. ENTERING THE MENU *(the thermostat is in the OFF state).*



To enter the menu of the thermostat that contains the setting you must press  for more than 3".

The screen will be lit and it will remain in this state during the programming of the settings. It must be stressed the only blinking indications can be adjusted. To navigate through the settings use the keys   while using the   keys to change the values. With the  key select the value that will be changed and with the  key we can return to the previous state. If no key is pressed for more than 2 minute then the device exits the programming mode and stores all the settings.



### 2. SELECTING DAY OR NIGHT MODE

*(the thermostat is ON and in manual operation).*







If the key  is pressed for more than 3" then the indication  is deactivated and the indication  is shown which means that night mode has been selected. This selection temporarily replaces the manual temperature setting with the night program setting for as long as it is active. If any of the keys   is pressed then the screen will show the selected temperature for the night program (it can be adjusted only through the setting *ni t* (night) in the

MENU). The factory default for this temperature is 18.0°C. To deactivate night mode press and hold the  key for more than 3". The symbol  will be replaced by the symbol .





### 3. SELECTING BOILER ACTIVATION *(only for BS-813).*

This option can be activated if we press and hold the  key for more than 3". The backlight will be lit and the symbol  will be shown on the top left of the screen while the internal relay will send the command to the burner. The command will be active depending on the time that has been adjusted in the MENU *bot* option (Boiler time), or until the key  is pressed again. By default, if the boiler time is set to 00 so the deactivation can only be done by the key. The Boiler command is independent from other thermostat functions and can even be issued with the thermostat deactivated (OFF state). The default boiler time is 30 minutes.









### 4. SELECTING AREA PRESENCE/ABSENCE *(the thermostat is in the ON state).*

In normal operation the symbol , shows the presence of a person in the room and all the selected programs are performed normally. For limited absence from the area (from a few hours to a few days) there is a capability to activate the absence program. If the key  is pressed for more than 3" then the backlight is activated for 2" and the symbol  will be replaced by the symbol . The selection overrides any other program. The preselected temperature can be shown on the screen by pressing one of the   keys and can not be altered. This temperature can be changed only via the option *Ab t* (Absent time in the MENU). The factory default value is 16.0 °C and can be adjusted from 6.0 to 30.0 °C. To deactivate the absence command press and hold the  key for more than 3", the thermostat will continue with the program that was running before the absence command was issued.







## 5. KEYBOARD LOCK *(in any operation mode).*



If the keys  and  are pressed simultaneously (first  then  ) for more the 3", the screen will show the message *LoC* and the keyboard will be locked. Whichever key is pressed after this will show the same message on the screen and no action will be done. All other functions continue to operate. To unlock the keyboard carry out the same procedure. The screen will show *ULoC*.

## 6. TIME AND DATE SETTINGS - *(the thermostat is in the OFF state).*

To adjust the time and date setting you must press and hold the  key for more that 3" as mentioned in paragraph 1. The backlight will be ON and in the lower part of the screen will show the blinking *SEt* message (Set Time). Immediately press the  key and the hour indications will blink. With the keys   change the value to the current hour. Pressing briefly the  key will make the minutes indicators to blink and with the keys   we can change the value. Pressing again the key  we can change the year, the month and the date. The top of the screen shows the day that changes depending on the settings of the year, the month and the date. In normal operation the clock is adjusted automatically for leap year and summer-winter time.





## 7. ADJUSTING SETTINGS FOR THE DAILY PROGRAM *(the thermostat is in the OFF state).*

If immediately after entering the MENU we press the  key the message *dAY* (DAY) will start to blink on the lower part of the screen and the word **DAY** on the top right. With the press of the key  the *PI* message is shown in place of the *dAY* message. In the center of the screen and, if the programming is done for the first time, the message *- - - -* is shown. By pressing the key  the hour indications blink and we can change to the correct value using the keys   . By pressing the key  we can change the minutes and after that the temperature.

With the key  we can return to the initial screen with the *PI* blinking. With consecutive presses of the key  we can select the remaining programs in the 24 hour base (10 in total) and to determine the required times and temperatures as described above. Please note that for every program we determine only the start time since the end time is the start time of the next program. For example, if we require a temperature of 23.0 °C from 14:00 to 18:00 in program 1 we will set the start time 14:00 at 23.0 °C and the start time of the second program 18:00 with the required temperature. The 24 hour time base starts at 00:00 and ends at 23:59'.





The start time of the next program must also be bigger than the start time of the previous. If no more changes are required and when the program indicator is blinking (e.i *P3*) we can press the key  to store all the changes and the screen will show the message *SAVE* . The programs that have not been adjusted are not taken into account.

## 8. ADJUSTING SETTINGS FOR THE WEEKLY PROGRAM. *(the thermostat is in the OFF state).*

If immediately after entering the MENU we press the  key for 2 times the message *7dAY* (7days) will be shown on the bottom of the screen and the word **WEEK** on the top right. On the top left of the screen there is the message **MO** (Monday) the shows the day that corresponds to the programming that follows. By pressing again the key  the screen shows a blinking *PI* that determines the first program of Monday of the weekly program. The remaining procedure is as described in paragraph 7. Finishing the programming of the first day if we press the  key while the program number is blinking (e.i *P3* ) will show the blinking message *7dAY*. With the key  we can select the day for which we want the alter the program as described above. If no other changes are required then press the  key to save the setting to memory. The screen will show the message *SAVE* . It is stressed that at least one program must be adjusted for every

day else the factory default temperature of 23.0 °C will be used for all the 24 hour base.

## 9. SELECTING THE UPPER AND LOWER LIMITS OF THE MANUAL TEMPERATURE ADJUSTMENT *(the thermostat is in the OFF state).*

After entering the MENU and by consecutive presses of the key  the message **HLL** (High Temperature Limit) will be shown on the bottom of the screen as well as the initial value 30.0 °C. By pressing the key  we can change this temperature between the lower **LLL** limit and the value of 30.0 °C. By pressing the key  and then immediately the  key the lower section of the screen shows the message **LLL** (Low Temperature Limit) as well as the initial temperature of 6.0 °C. With the key  we can adjust the value between 6.0 °C and the value of the upper limit. The two limits define a temperature area that can be used by the user to enter the desired temperature. The selection of the limits influences the manual adjustment of the temperature and is independent from the operating mode of the unit (manual, daily weekly) and does not have any influence on the programs for daily or weekly operation.

## 10. OTHER MENU SETTINGS *(the thermostat is in the OFF state).*

After entering the MENU use the  key to select the required setting. The messages are shown in the bottom section of the screen like this:

### A. **Mode (Mode) OPERATION MODE.**

One of three operation modes can be selected:

**USER** (User) Manual mode (the symbol **MAN** is shown on the top right of the screen).

**DAY** (Day) daily operation (the symbol **DAY** is shown on the top right of the screen).

**7DAY** (7 Days) weekly program (the symbol **WEEK** is shown on the top right of the screen).

The factory default is **USER**.

### B. **Unit (Unit) TEMPERATURE UNIT.**

The option are: **DEGC** or **DEGF** (Degree Celsius ή Degree Fahrenheit) and regard the display of the temperature in °C or °F.

Depending on the selection, the symbol °C or °F are shown on the center right of the screen.

### C. **bl (Back Light) SCREEN ILLUMINATION.**



With this setting we can turn off the screen illumination in order to conserve battery energy. If **on** (ON) is selected then the screen illumination will be activated every time a key is pressed. If **OFF** is selected then the screen illumination will be deactivated.

The factory default is **on**.

### D. **LED (LED) BURNER OUTPUT INDICATOR.**

This setting can deactivate the burner output indicator in order to conserve battery energy. If **on** (ON) is selected then, when the burner output is active, the indicator will briefly blink every second so the user has a knowledge of the state of the thermostat from a distance. If **OFF** (OFF) is selected then the indicator is deactivated.

### E. **toUt (Time Out) TEMPORARY TIME FOR MANUAL OPERATION.**

With this setting we can determine the time period for which the manual temperature adjustment is valid. When the thermostat is running a daily or weekly program and we press the keys  or  then the thermostat enters briefly the manual mode for a time period that is determined by the setting **toUt**. The value of this setting can be from 3 to 10 hours after which normal program execution is continued. The factory default is 3 hours.

### F. **d,ff (Differential) DIFFERENTIAL SETTING.**

This setting determines the "temperature window" between activation and deactivation of the burner output. For example, if the thermostat is set to heating and the room temperature is set to 23.0 °C then with a differential of 0.5 °C the output to the burner will be deactivated at 23.0 °C and will be reactivated at 22.5 °C. If the device is set to cooling mode then the output will be deactivated at 23.0 °C and will be reactivated at 23.5 °C. The differential value can be set between 0.2 °C and 4.0 °C.

The factory default value is 0.5 °C.

### G. $HEC_{o}$ (Heat/Cold). **SELECTING HEATING/COOLING MODE.**

This setting determines the operation mode of the thermostat which can be heating or cooling. By selecting  $HEAT$  the device can control heating units (e.i. diesel burners), whereas with the selection  $Cold$  it can control cooling units (e.i. air-conditioners).

### I. $T_{NE}$ (Time) **HOUR METER.**

In this position the time count of time is shown that the burner or cooling unit operates, depending on the setting Heat/Cold. The value of counting time can not be changed from the keyboard but resets if the battery is disconnected. The maximum value is 9.999 hours.

### H. $FACT$ (Factory settings) **SELECTING THE FACTORY DEFAULT SETTINGS.**

If for any reason there is the need to restore the thermostat to its factory default settings then this setting will restore then is we select  $FACT$  and press the key .

### 11. CHANGING THE BATTERY

When the screen shows the  symbol the unit warns the user that the batteries have limited energy and that they must be replaced in the next 3 weeks. To replace the batteries simple remove the cover (photo 2) to expose the battery compartment. Take care of the battery orientation and insert the new batteries according to the graphic representation etch on the plastic base. The reverse installation will not harm the device, but it will permit it to operate.

The battery life time has been design to be approximately 3 years. Factors that influence the battery life are prolong use of the keyboard with the backlight active, low temperature and high humidity as well as battery quality. When you remove the batteries, the device will operate normally for 30sec without losing time-date settings.

### 12. ANTI-ICE PROTECTION

If the room, in which the thermostat is installed, falls below  $5^{\circ}C$ , the unit activates the burner output irrelevant of the ON or OFF state of the thermostat to prevent ice build up. The burner output is active for as long as the temperature is below  $5^{\circ}C$ .

### 13. CLEANING THE THERMOSTAT

To clean the device use a damp cloth to remove any dust or stains from the covers. Do not use any liquid or dissolvers that will damage the plastic covers.

### 14. SCREEN MESSAGES

Following you can see a complete list of screen messages that can be seen by consecutively pressing the  key:

$Set$  = Set Time = Time and date setting.

$DAY$  = Day = Daily program selection.

$WDAY$  = Week = Weekly program selection.

$Mode$  = Mode = Operation mode selection.

$Unit$  = Unit = Temperature unit.

$bl$  = Backlight = Screen illumination.

$LED$  = LED = Burner output indication LED.

$timeout$  = Time out = Manual temperature time.

$HLL$  = High Temperature Limit = Upper limit for manual temperature adjustment.

$LTL$  = Low Temperature Limit = Lower limit for manual temperature adjustment.

$boot$  = Boiler Time = Active boiler time

$d_{FF}$  = Differential = Differential for burner relay.

$absent$  = Absent = Absence program.

$night$  = Night = Night program.

$HEC_{o}$  = Heat/Cold = Heat/Cold operation mode.

$FACT$  = Factory = Factory default settings.

### MISCELLANEOUS INDICATIONS

$lock$  = Lock = Keyboard lock.

$unlock$  = Unlock = Unlock keyboard.

$save$  = Save = Save settings to memory.

$user$  = User = Manual program

$degC$  = Degree Celcius = Celcius temp. unit.

$degF$  = Degree Fahrenheit = Fahrenheit temp. unit.

$PI$  = Program 1 to 10 = Program number from 1 to 10

### FACTORY DEFAULTS

The following values are the factory defaults:

*Thermostat state* = **Inactive (OFF)**

*Daily and weekly programs* = **Not set**

*Operation mode* = **Manual (User)**

*Value of selected temperature* =  **$23.0^{\circ}C$**

*Normal or Night program* = **Normal**

*Temperature unit* = **Degrees Celsius**

*Screen illumination* = **Active (On)**



Burner activation indicator = **Active (On)**

Absence program = **Presence**

Manual selection time = **3 hours**

Upper manual temperature limit = **30.0°C**

Lower manual temperature limit = **6.0°C**

Boiler operation time = **00 minutes**

(BS-813 only)

Boiler state = **Inactive (BS-813)**

Differential = **0.5°C**

Absence temperature = **16.0°C**

Night temperature program = **18.0°C**

Heating-Cooling function = **Heating**



Keyboard state = **Unlocked**

## DAILY PROGRAMMING EXAMPLE



Lets assume that we want to program the following temperatures and hours (programs): From 07.00 to 08.30 at 22,5°C. From 8.30 to 12.00 at 21,5°C. From 12.00 to 17.30 at 18.5°C. From 17.30 to 23.00 at 22.5°C and from 23.00 to 07.00 at 19,8°C.

Note that the end hour of each program is the start hour of the next program and always the start hour of a program is at least 1 minute greater than the end hour of the previous program. It is essential to select at least 1 program per day otherwise the thermostat will operate with the factory defined temperature of 23°C. Also note that the first program is considered the program with the start hour nearest to the hour 00.00 (e.i. 07.00).



1. Turn OFF the thermostat by pressing the corresponding key.

2. Press continuously the key  for 3 seconds . The screen back light is activated and the screen shows . Now we are in programming mode of the thermostat parameters.



3. Press the key  9 times and the screen shows  with the *ModE* (Mode) blinking.



4. Press the key  and the *USER* starts to blink. With the keys  and  we select the operation mode *DRY* (Day - daily program).



5. Press the key  and we return to the previous screen with the *ModE* blinking.



6. Press the key  8 times and the screen shows  with the *DRY* blinking. Now we are in the daily programming sub menu that

has a 10 program capability.

7. Press the key  and the screen shows  with the *P1* blinking, this shows that we are in program 1 of the daily program. (the indication *--:--* indicates that the current program in empty).

8. Press the key  and the hours digit starts to blink. With the keys   select 00.

9. Press the key  and the minutes digit starts to blink. With the keys   select 00.



10. With the next press of the  key the screen shows the temperature blinking and by using the   keys we select 19,8°C. This concludes the programming of the first program.

11. Press the  key and the screen shows the symbol *P1* blinking.

12. Press the  key and the *P2* symbol will blink. This shows that we are in the second program.

13. Follow the step 8, 9 and 10 and set the time to 7.00 (which is the end time of the first program) and the temperature to 22,5°C.

14. Following the steps 8, 9, 10 and 11 to adjust the remaining programs with the values 8.30/21,5°C, 12.00/18,5°C, 17.30/22,5°C and 23.00/ 19.8°C. If by mistake we add a new program (ex. P6), this program can't be canceled but can be defined as a new program with a start time of 23.01 and the same temperature as P5.

15. Completing the daily program we can store the programmed values to the devices memory by pressing 2 times the  key while the indication *P5* is blinking. The screen will show  for awhile and then normal operation will continue. By activating the device with the  key the daily program will start to take affect. In order for the program to execute correctly make sure you have programmed the device clock with the correct time.

## WEEKLY PROGRAMING EXAMPLE

The weekly program in general is based on the daily programming which is repeated for every day of the week independently. For the days of the week that have not been programmed, the values of the last programmed day are valid. If for example, we program only the days Monday to Wednesday, then the programming for Wednesday will be used for the days Thursday to Sunday. If we program only the days Monday, Wednesday and Thursday then for Tuesdays program the program from Monday will be used and for the days Friday, Saturday, Sunday the program from Thursday will be used.

1. Follow the steps 1, 2, 3, and 4 of the daily programming. Select in the *Mode* section the setting *7dAY* and press the key **ESC**.

2. Press 7 times the **7** key and the screen shows **Mon 7dAY** with the *7dAY* indication blinking. The symbol **MO** (Monday) means that we are ready to program the Monday program and the symbol **WEEK** that we are in weekly programming mode.

3. Press the **MENU** key and the screen shows **---**. From now the procedure follows the steps 8-14 of the daily programming and we can set the required temperatures on the required time.

4. Completing the programming of the Monday program press the **ESC** key and the screen shows **Mon 7dAY** with the *7dAY* indication blinking. By pressing the **7** key the day indicator changes to **TU** (Tuesday) and we can repeat the steps for programming a new program for Tuesday. The same can be done for the rest of the days of the week.

5. The completion of the weekly programming can be done by pressing the key **ESC** when the indicator *7dAY* is blinking. The screen will show the **SAVE** message briefly and the settings will be stored in to the devices memory.

6. Activate the device using the **ON** key. The weekly program will start to execute as defined. In order for the program to execute correctly make sure you have programmed the device clock with the correct time.

### Dimensions in millimeters

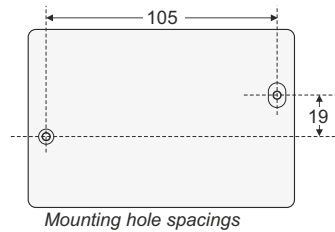
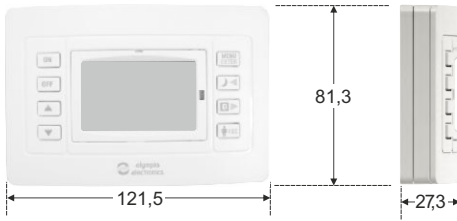

### TECHNICAL CHARACTERISTICS

TYPE	BS-812	BS-813	BS-814
BATTERIES	2 Alkaline AA		
TEMPERATURE MEASUREMENT RANGE	0.0 to 99.9 °C		
TEMPERATURE SELECTION RANGE	6.0 to 30.0 °C		
FREE RELAY CONTACT	5A - 250V AC	2 x 5A - 250V AC	12A - 250V AC
DEGREES OF COVER PROTECTION	IP 20		
PRODUCED IN ACCORDANCE WITH	EN 61000-6-1, EN 61000-6-3, EN 60730-1, EN 60730-2-9		
OPERATION TEMPERATURE RANGE	5 to 35 °C		
RELATIVE HUMIDITY	0 - 90% RH		
EXTERNAL DIMENSIONS	121.5 x 27.3 x 81.3mm		
TYPICAL WEIGHT (including batteries)	180gr	190gr	185gr
GUARANTEE	2 years		

## Installation procedure

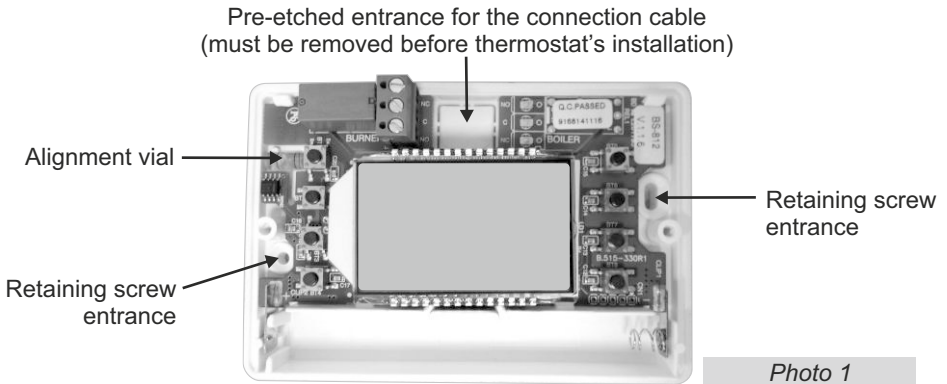

Photo 2

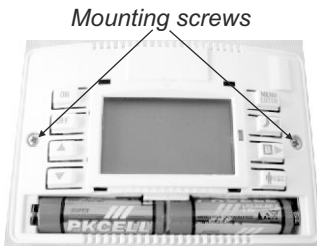

Photo 3

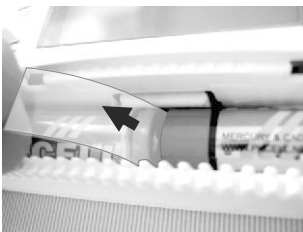

Photo 4

(The following procedure must be done with the main power supply isolated)

- ① To install the device, use a flat blade screwdriver to pry up the cover, with the same width as the plastic opening (photo 2).
- ② Unscrew the retaining screws and remove the plastic cover containing the keys (photo 3).
- ③ Use the supplied support screws and plugs after opening the required holes on the mounting surface (photo 1). Install the base and align using the built-in alignment vial. Tighten the retaining screws.
- ④ Press and remove the pre-etched cable entry (photo 1). Perform the connections as shown in the diagrams on page 8.  
**THE NEUTRAL IS NOT CONNECTED.**
- ⑤ Reinstall with care the plastic with the keys and fasten the mounting screws. Maximum tightening torque 0,5 N\*m.
- ⑥ To activate the device remove the battery separator (photo 4).
- ⑦ Reinstall the plastic cover and press gently until it snaps into position. The unit is ready to operate.



## Electrical connections

### BS-812

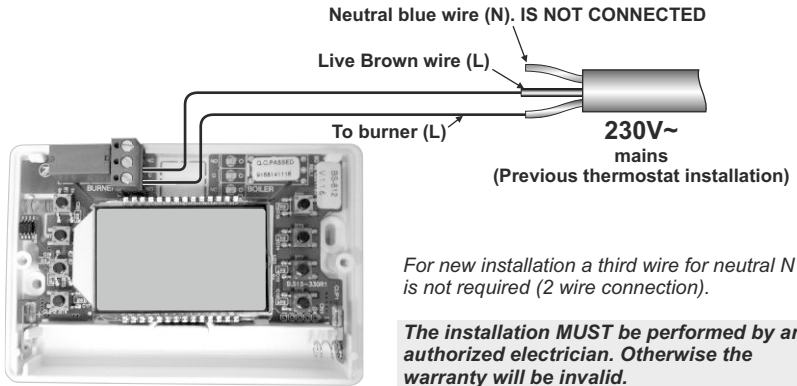

### BS-813

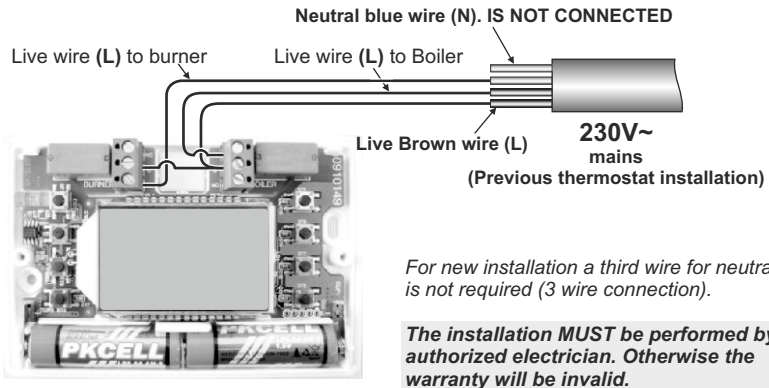

### BS-814

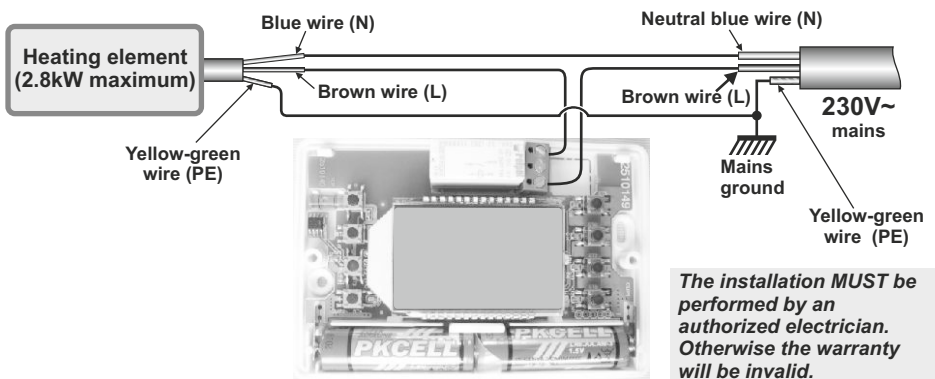

### WARRANTY

Olympia Electronics guarantees the quality, condition and operation of the goods. The period of warranty is specified in the official catalogue of Olympia Electronics and also in the technical leaflet, which accompanies each product. This warranty ceases to exist if the buyer does not follow the technical instructions included in official documents given by Olympia Electronics or if the buyer modifies the goods provided or has any repairs or re-setting done by a third party, unless Olympia Electronics has fully agreed to them in writing. Products that have been damaged can be returned to the premises of our company for repair or replacement, as long as the warranty period is valid.

Olympia Electronics reserves the right to repair or to replace the returned goods and to or not charge the buyer depending on the reason of defection. Olympia Electronics reserves the right to charge or not the buyer the transportation cost.

### HEAD OFFICE

72nd km. O.N.R. Thessaloniki-Katerini  
P.C. 60300 P.O. Box 06 Eginio Pierias Greece

[www.olympia-electronics.gr](http://www.olympia-electronics.gr)

[info@olympia-electronics.gr](mailto:info@olympia-electronics.gr)